

LIMO-LD80-F600-3

High Power Fiber for Laser Diodes



| Photonics Solutions |
| Materials Processing Solutions |

product similar to image

Fiber specifications	unit	value	unit	value
Optical data			Mechanical Data	
Wavelength range	nm	600...1700	Fiber core diameter	µm 600
Numerical aperture		0,22	Fiber cladding diameter	µm 720
Coating AR-bandwidth	nm	not specified	Length	m 3
Max. acceptable laser power (core)	W	500	Short term bending radius	cm 5,4
Max. acceptable laser power (cladding)	W	not specified	Long term bending radius	cm 21,6
			Fiber connector 1	LD80
			Fiber connector 2	LD80
			Fiber jacket	high protective metal
			Fiber jacket coating	PVC

Additional features

Mode stripped (cladding mode free)	not available
Fiber break detection	not available

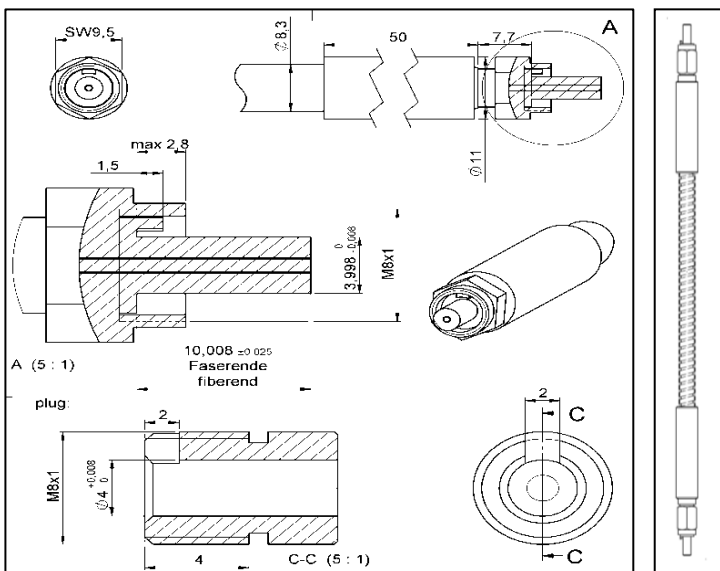

LD-80 Connector

Copyright © 2017 LIMO GmbH. All rights reserved. All LIMO products are patent pending. Subject to change without notice.

Version December 20, 2017