

FAC-SAC Collimation Module

Product number: MOD000631

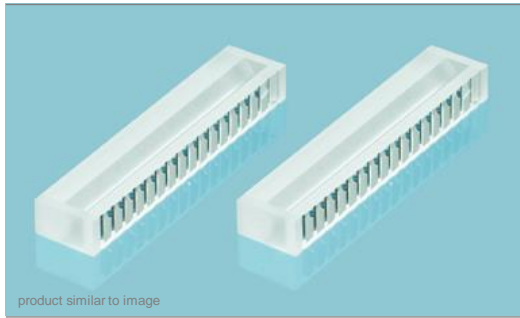

General Description:

| Advanced Optical Solutions |

Collimation module consisting of FAC910 and SAC100-500 mounted with side tabs for the collimation of the fast and slow axis of diode lasers. Emitter size of up to 100 μm and pitch 500 μm .

Specification Data

	Unit	Value
Material		S-TIH53 (Ohara)
Length (L)	mm	11.5 ± 0.25
Width (W)	mm	1.5 ± 0.05
Thickness (T)	mm	3.71 ± 0.05
Clear aperture	mm^2	9.5×1.4
Surface quality @ 633 nm		$\lambda/4$ (typically)
Back focal length (BFL) @ 808 nm	mm	0.09
Pitch	mm	0.5
Standard coating - AR	nm	790-990
Transmission	%	> 98
Fast axis power within an angle of ± 0.7 mrad	%	> 85
Slow axis remaining divergence FW $1/e^2$	mrad	40 (typically)

Options

- Customized coating
- Bottom tab for mounting

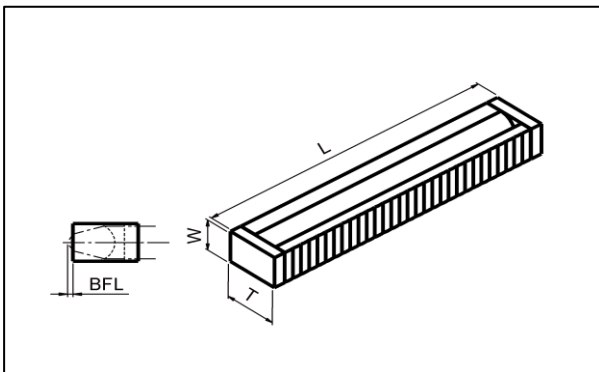

RoHS compliant
2002/95/EG

Copyright © 2011 LIMO GmbH. All rights reserved. All LIMO products are patent pending. Subject to change without notice.

Version December 19, 2017