

LIMO120-F200-DL980-S3010

High Power Diode Laser

No image available.

product similar to image

Your product benefits:

- Plug and play fiber connector
- High e/o efficiency
- Hermetically sealed housing
- 100% emitter and fiber incoming inspection
- 100% laser outgoing inspection

| Photonics Solutions |

LIMO laser and optics designed and engineered in Germany

Laser Module	Unit	Value	Unit	Value
Optical Data		Fiber Connection Data		
CW - nominal output power	W	120	Fiber core diameter	μm 200
Center wavelength	nm	980	Numerical aperture	0,22
Wavelength tolerance (±)	nm	10	Fiber - optic connector	SMA
Spectral width (FWHM)	nm	20	Cladding mode (max)	% not specified
Wavelength temperature drift	nm/K	0,4		
Thermal Operation Conditions		Package		
Nominal diode heat sink temperature	°C	25	Dimensions	mm ³ 197x100x58
Diode heat sink operation temperature	°C	+15...30	Weight basic package	kg 2,2
Minimum heat sink capacity	W	300	Storage temperature	°C -20...+60
Chiller flow capacity	l/min	5		
Water pressure	bar	4		
Electrical Data				
Max. operation current start of life	A	65		
Max. operation current end of life	A	78		
Typical threshold current	A	8		
Typical operation voltage	V	6		
Typical slope	W/A	2,4		
Typical O/E efficiency	%	39		
Additional Features		Monitor Diode		
Pilot Beam				
Output power (min)	mW	1	Operation voltage	V 5
Wavelength	nm	635	Output signal (min)	V 0
Voltage	V	5	Output signal (max)	V 2,5
Current (max)	mA	40		
Fiber Detection Sensor (PNP)		Other Features		
Voltage	V	Not available	Temperature sensors	NTC & PT100
Current (max)	mA	Not available	Wavelength stabilization	Not available
Protection Filter				
High reflection bandwidth (>99.0% s+p pol.)	nm	Not available		

LIMO120-F200-DL980-S3010

High Power Diode Laser

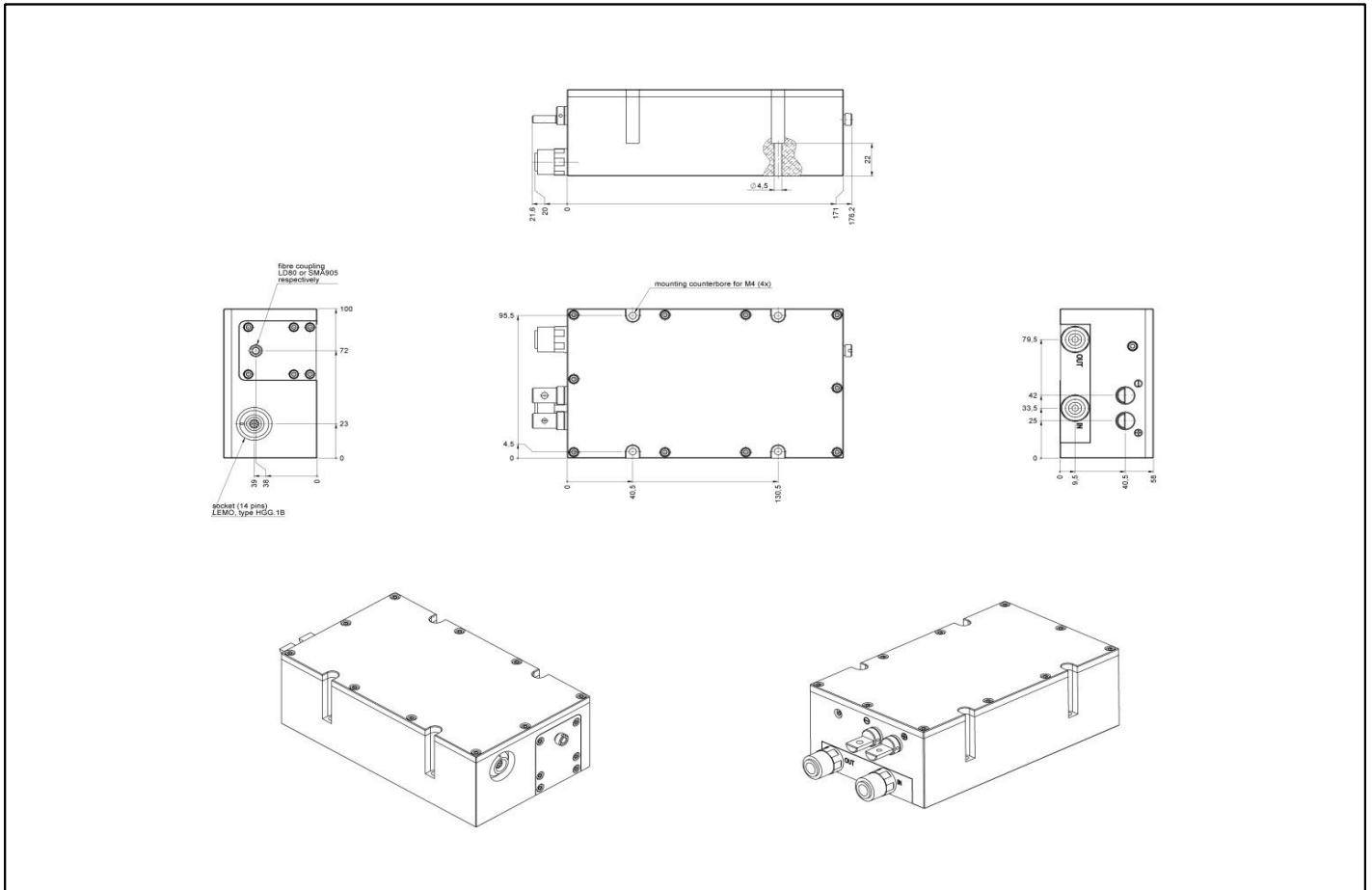

LIMO120-F200-DL980-S3010 prepared for water cooling

All data provided are typically measured with a diode heat sink temperature of 25 °C. All measurements are made with a LIMO reference fiber 200 µm, length 1.5 m, and non AR coated.

Copyright © 2017 LIMO GmbH. All rights reserved. All LIMO products are patent pending. Subject to change without notice.

Version December 20, 2017