

LIMO-SMA905-F200-3

High Power Fiber for Laser Diodes



product similar to image

| Photonics Solutions |
| Materials Processing Solutions |

Fiber specifications	unit	value	unit	value
Optical data			Mechanical Data	
Wavelength range	nm	600...1700	Fiber core diameter	µm 200
Numerical aperture		0,22	Fiber cladding diameter	µm 280
Coating AR-bandwidth	nm	not specified	Length	m 3
Max. acceptable laser power (core)	W	150	Short term bending radius	cm 2.1
Max. acceptable laser power (cladding)	W	not specified	Long term bending radius	cm 8.4
			Fiber connector 1	SMA905
			Fiber connector 2	SMA905
			Fiber jacket	high protective metal
			Fiber jacket coating	PVC

Additional features

Mode stripped (cladding mode free)	not available
Fiber break detection	not available

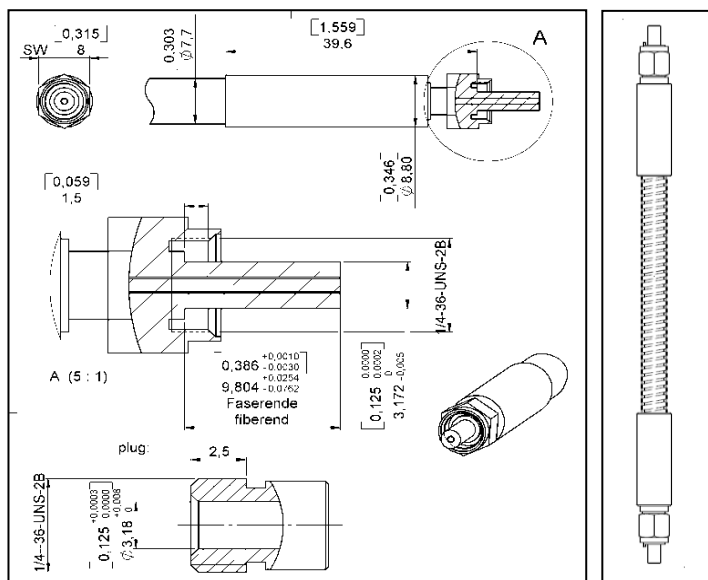

SMA Connector

Copyright © 2017 LIMO GmbH. All rights reserved. All LIMO products are patent pending. Subject to change without notice.

Version December 20, 2017