

Telescope Array - TEL 150/500

Product number: ZLA000390

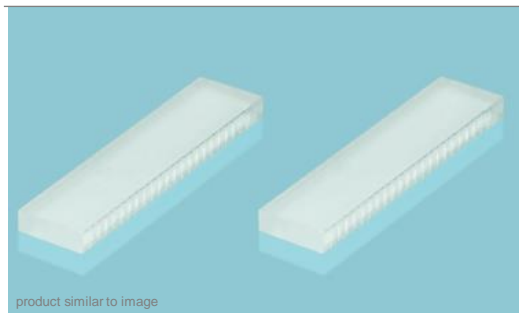

General Description:

| Advanced Optical Solutions |

Telescope-Array for the collimation of the slow axis of diode laser bars with emitter size of up to 150 μm and pitch 500 μm .

Specification Data

	Unit	Value
Material		S-TIH53 (Ohara)
Length (L)	mm	12.0 ± 0.05
Width (W)	mm	1.5 ± 0.05
Thickness (T)	mm	4.5 ± 0.01
Clear aperture	mm^2	11.0×1.4
Surface quality @ 633 nm		$\lambda/4$ (typically)
Refractive index n @ 808 nm		1.823
Effective focal length (EFL) @ 808 nm	mm	2.48
Pitch (P)	mm	0.5
Average radius	mm	Side A: 2.05 ± 0.04 Side B: 3.95 ± 0.08
Numerical aperture (NA)		0.09
Standard coating - AR	nm	790 - 990
Transmission	%	> 99
Remaining divergence FW $1/e^2$	mrad	65 (typically)

Options

- Customized coating
- Other dimensions
- Bottom tab for mounting

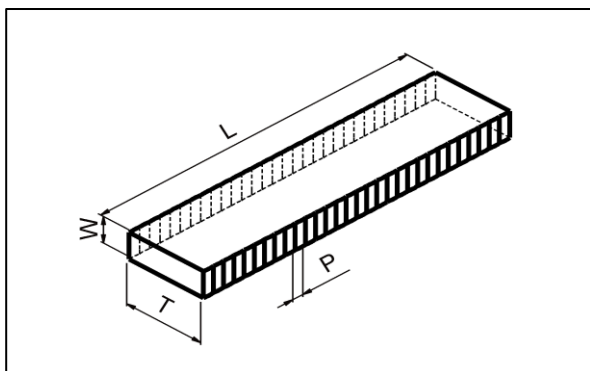

RoHS compliant
2002/95/EG

Copyright © 2011 LIMO GmbH. All rights reserved. All LIMO products are patent pending. Subject to change without notice.

Version June 22, 2018